

RADON IN EXISTING BUILDINGS

Corrective Options

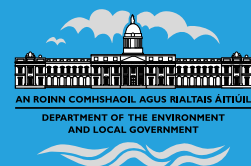

Printed on recycled paper containing a minimum of 75% post-consumer waste.



RADON

IN

EXISTING BUILDINGS

Corrective Options

January 2002

RADON IN EXISTING BUILDINGS

Corrective Options

Published by the Stationery Office, Dublin

To be purchased from:

The Government Publications Sales Office

Sun Alliance House

Molesworth Street

Dublin 2

Price €5.00

Contents

| | <i>Page</i> |
|--|-------------|
| Introduction | 5 |
| 1 Facts about Radon | 6 |
| 2 Indoor Radon – points of entry | 6 |
| 3 Methods of detection and measurement of Radon | 7 |
| 4 Reference Level | 8 |
| 5 Preventative and Corrective options | 9 |
| Sealing soil gas routes | 11 |
| Depressurisation/pressurisation of underlying soil | 11 |
| Ventilation of sub-structures | 17 |
| Ventilation of internal spaces | 17 |
| Pressurisation of internal spaces | 18 |
| 6 Flue gas spillage | 19 |
| 7 Landfill gas | 20 |
| 8 Conclusion | 20 |
| 9 Maps | 20 |
| 10 References | 26 |
| 11 Further reading | 27 |

Introduction

Radon is a naturally occurring radioactive gas found in varying amounts in all soils and rocks. It is accepted that long term exposure to radon can cause lung cancer and there is growing evidence that the risk from radon is considerably greater for those who smoke than for those who do not smoke. The Government, on the advice of the Radiological Protection Institute of Ireland (RPII), has set a National Reference Level of 200 Becquerels per cubic metre (200 Bq/m³) above which remedial action to reduce the indoor radon gas level in a dwelling should be considered.

The RPII completed a national survey of radon levels in existing houses in 1999. The survey showed that an estimated 91,000 houses, or 7% of the total housing stock of 1.25 million houses, had radon gas concentrations above the national Reference Level. Based on the results of the survey the RPII have identified **High Radon Areas** – where it is estimated that 10% or more of the existing houses have radon gas concentrations above 200 Bq/m³. However, houses with high levels of radon gas are not confined to these areas and high levels of radon gas concentrations can occur in individual dwellings in any part of the country.

This Guide incorporates the RPII radon prediction maps showing the location of the High Radon Areas, which are included with the kind permission of the RPII. The RPII also provide a radon measurement service to members of the public who wish to have the radon levels measured in their house. There is a charge for this service, currently it is €19.

This Guide is published by the Department of the Environment and Local Government. It is intended to inform designers, contractors, and building owners about radon and the means to deal with high concentrations in *existing buildings*. It gives some pointers as to good practice insofar as it relates to non-complex buildings of normal design and construction. Reference is made to the usual ways of minimising levels of radon gas and guidance is given on sources of further information. It is not intended as a comprehensive document covering all aspects of design and construction to limit indoor radon levels, but rather as a source of basic information to assist in making informed decisions on the subject. It does *not* deal with other performance requirements such as damp proofing, insulation etc. which should also be acknowledged in design and construction.

Under the Building Regulations, all *new buildings* must incorporate radon protection measures. Guidance on radon protection for new houses commencing on or after 1 July 1998 is contained in the 1997 edition of Technical Guidance Document (TGD) – C (Site Preparation and Resistance to Moisture)¹. The Guidance for non-complex houses of normal design and construction is summarised as follows,

- *High Radon Areas*: a membrane is to be provided over the footprint of the building as described in Technical Guidance Document – C, together with a potential means of radon extraction such as a sump or sumps with connecting pipework, which can be activated if a post construction survey shows a radon concentration exceeding the reference level. A post construction survey is recommended in High Radon Areas.
- *Areas other than High Radon Areas*: provide a potential means of radon extraction such as a sump or sumps with connecting pipework, which can be activated if a post construction radon survey shows a radon gas concentration exceeding the Reference Level.

Useful information on the practicalities of the action required under the Building Regulations is also provided for homebuilders by HomeBond in their information leaflet “Right on the Site – Radon”. In addition, the Departments Environmental Information Service (ENFO) has published a leaflet on Radon.

The installation of Radon remediation or prevention measures in accordance with this booklet or Technical Guidance Document C is *not* a warranty that Radon levels will be reduced below the national Reference Level of 200 Bq/m³.

The Government plan to introduce a Radon Remediation Grant Scheme for existing houses. The Scheme, to be administered by the RPII, will be introduced once the necessary legislation is in place. The grant will cover 50% of the cost of remediation work, subject to a maximum grant of €1016.

Householders or landlords planning to undertake radon remediation works are advised to consider retaining the services of a professional to design and supervise the works; and a suitably qualified and experienced contractor to carry out the works. FÁS maintain a register of persons who have successfully completed the training programme “Radon Gas Remediation and Prevention”.

The relevant building contract should include a provision for a post remediation radon survey, as the installation of radon remediation measures is not a warranty that radon gas levels will be reduced below the national Reference Level.

This booklet also briefly refers to radon protection in the *workplace*.

The RPII offers free post remediation measurements to householders who have completed radon remediation work in their homes. Details of this scheme are available from the RPII. The RPII can be contacted at 3 Clonskeagh Square, Clonskeagh Road, Dublin 14, telephone 01-2697766.

1. Facts about Radon

Radon is a naturally occurring radioactive gas, which has no taste, smell or colour and requires special equipment to detect its presence. The level of radioactivity in the air due to the presence of radon gas is measured in becquerels per cubic metre (Bq/m³).

Approximately 90% of the total annual radiation dose received by the general public is derived from natural sources. The single largest component of this dose is that due to radon and its decay products in the indoor environment. On the basis of current Irish data, radon contributes over 50% of the total radiation dose received by the Irish population².

When radon is generated in porous rock and soil some of it enters the pore spaces where it becomes a constituent of the soil gas. This soil gas rises to the surface and is exhaled into the atmosphere throughout our natural environment. In the outdoor environment it is rapidly diluted and dispersed. However, if the radon flux enters the air space of a building then elevated indoor radon levels may occur due to restricted dispersion. For further information on radon gas see the *ENFO Briefing Sheet 15*³.

2. Indoor Radon – Points of Entry

Buildings in general tend to have a slightly lower indoor air pressure compared to that in the ground. This is normally sufficient to draw soil gas from the ground into the building.

Radon gas can enter a building by many mechanisms but the most significant are diffusion and pressure-driven flow from the ground beneath and immediately adjacent to the building, provided suitable ingress routes are available. Ingress routes for radon gas are usually cracks and holes in floors and walls, and gaps around service pipes and cables (*Figure 1*). In most dwellings with elevated indoor radon concentrations pressure-driven flow is recognised as the dominant mechanism of ingress.

Radon from domestic water and gas supplies and from building materials can contribute to the indoor radon concentration in a building, but in most cases the contribution is considered minor when compared with that from the soil gasses in the ground on which the building is constructed.

Radon gas is heavier than air, and therefore it is not normally a problem in the upper stories or high rise buildings.

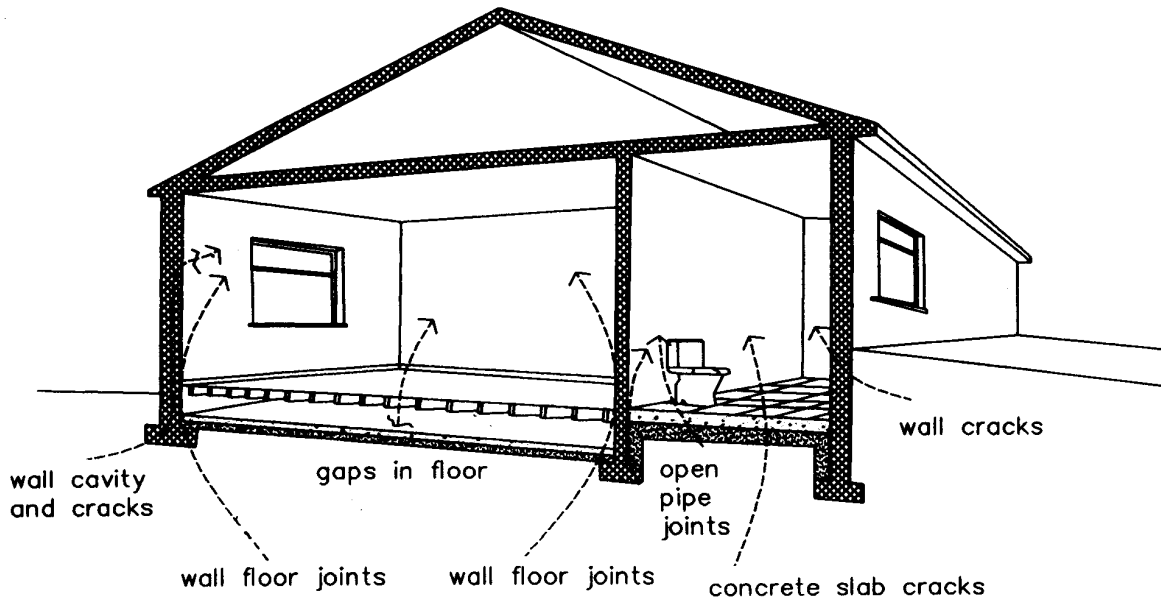

Fig 1 major entry routes

3. Methods of Detection and Measurement of Radon

Radon measurements in existing buildings

Predictions of indoor radon levels in advance of construction based on building type, geology or other building parameters are generally considered to be unreliable. Consequently, the only practical way to determine if a building has a radon problem is to measure radon in that building post construction. Survey protocols, which measure the long-term average radon concentration, give the most reliable indication of whether or not a radon problem exists. The RPII recommends that, where practicable, such *measurements should be made over a period of not less than 3 months*. Indoor radon levels can vary considerably from hour to hour or day to day and so measurements averaged over this duration are considered necessary in order to give an accurate representation of the radon exposure to occupants. Long term average radon measurements in an existing building can be measured relatively simply and inexpensively using a passive device, such as an alpha track etch detector.

Alpha track etch detectors used to measure radon gas consist of a radiation sensitive element located inside a small plastic chamber. The radiation sensitive material most commonly used in these detectors is a thermoset resin known commercially as CR-39^a (polyallyl diglycol carbonate). The chamber is designed to allow the entry of radon gas by diffusion but to prevent the entry of aerosols. The alpha radiation released by the radon gas and its decay products inside the chamber, strikes the radiation sensitive material and damages it on a microscopic level. After chemical processing, the radiation damage on the element is analysed and the average radon concentration to which the detector was exposed during the measurement period is determined. Alpha track etch detectors are not radioactive and pose no hazard to users.

For radon surveys in domestic dwellings it is common practice to use two alpha track etch detectors for a period of three to six months. In larger buildings a greater number of detectors would usually be necessary. Detailed advice on planning radon surveys in workplaces is set out in the RPII's guidance document "Planning Radon Surveys in the Workplace"⁴, which can be downloaded free of charge from the RPII website (www.rpii.ie).

^a CR-39 (Columbia Resin 39) is a trademark

Indoor radon can also be monitored by active radon measurement techniques, but these techniques are normally suitable only for monitoring radon levels and fluctuations over short periods. Such measurements might, for example, be made for diagnostic purposes during the course of remedial work. The results of active measurements should be interpreted with care, as they are likely to be influenced by weather conditions and building usage patterns prevailing at the time of measurement. Active measurement techniques are not economically viable for the assessment of long-term average indoor radon levels. Active techniques should only be carried out by surveyors who have undergone appropriate training. Further information on active measurement techniques can be found in *The Radon Manual*⁵.

The National Radon Survey

The RPII conducted the National Radon Survey for Irish dwellings. The survey quantifies the scale of the radon problem in Irish dwellings and identifies those parts of the country where high indoor radon levels are more likely to be found.

During the course of the survey, long-term average radon concentrations were measured in a random selection of houses in each 10 x 10 km National Grid square throughout the country. The results were used to predict the percentage of houses in each grid square with indoor radon gas concentrations in excess of 200 becquerels per cubic metre (Bq/m³), the national Reference Level. Grid squares where the predicted percentage is greater than 10% are designated High Radon Areas.

In total valid radon measurements were completed in 11,319 dwellings. 993 dwellings, or 8.8% of the dwellings surveyed, had radon concentrations in excess of the Reference Level of 200 Bq/m³. The population weighted average indoor radon concentration for the dwellings surveyed was 85 Bq/m³.

Based on the results of the National Radon Survey the RPII has published a map “*Radon in Irish Dwellings*” showing the predicted percentage of houses above the national Reference Level for each 10 km grid square. The map in four sections is contained in Section 9. An A1 version of this map may be purchased directly from the RPII. Alternatively the map can be viewed county by county on the RPII’s Web site.

It is important to note that the National Radon Survey looked only at domestic dwellings and so predictions of the percentages of dwellings above the national Reference Level can not be applied directly to schools, workplaces or other building types. However, it is to be expected that in grid squares, where the National Radon Survey predicts an elevated number of houses with high radon levels, workplaces, schools and other building types are also more likely to be high.

4. Reference Level

Homes

Many countries world-wide have adopted national reference levels within the range 200 to 600 as recommended by the International Commission on Radiological Protection.⁶ In 1990, the Government, on the advice of the then Nuclear Energy Board, adopted an annual average radon gas concentration of 200 Bq/m³ as the national Reference Level above which remedial action to reduce indoor radon in domestic dwellings should be considered.

Workplaces

Since May 2000, occupational exposure to natural radiation sources, including radon, has been subject to regulatory control in Ireland. This change is in line with the most recent revision to the Euratom Basic Safety Standards Directive (Council Directive 96/29/EURATOM)⁷, which establishes a common basis for radiation protection legislation in all European Union Member States.

In Ireland the necessary regulations to comply with the Directive were brought into force by the “Radiological Protection Act, 1991 (Ionising Radiation) Order, 2000” (Statutory Instrument No. 125 of 2000), hereafter referred to as the Ionising Radiation Order⁸. The RPII has been assigned particular responsibilities under the Ionising Radiation Order.

The Ionising Radiation Order sets a national Reference Level for radon gas in workplaces of 400 Bq/m^3 averaged over any three-month period. In accordance with this Order, an employer or self-employed person responsible for a workplace is required to measure radon levels in the workplace on being directed to do so by the RPII.

If radon levels in a workplace are found to exceed the Reference Level, the Ionising Radiation Order requires that the undertaking take measures to safeguard the health of workers. These measures are summarised below:

- The undertaking must evaluate whether remedial measures to reduce the radon levels in the workplace should be undertaken.
- Where this evaluation shows that radon remedial measures are justified, the undertaking must implement such measures as soon as practicable.
- Where remedial measures are shown not to be justified or where they fail to bring levels below the Reference Level, the undertaking must apply radiation protection measures in the workplace. Such measures might, for example, include organisation of work schedules to reduce exposure, making and keeping of exposure records, medical surveillance and controlling access to parts of the workplace where radon levels have been shown to be high.

5. Preventative and Corrective Options

Preventative and corrective options are aimed at either preventing radon entering the building or removing radon after entry.

Techniques, which prevent radon entry, include:

- sealing soil gas routes into the building;
- sub-floor depressurisation (or pressurisation) with passive or fan-assisted sumps to draw (or force) soil gas away from the building before it can enter;
- sub-structure ventilation;
- ventilation and adjustment of the air pressure inside the building to reduce or reverse the driving force which assists the entry of soil gas.

Information published by the Building Research Establishment (BRE)⁹ suggests that the expected effectiveness of the various options are as shown in *Figure 2*. BRE has also published a document¹⁰, which modifies *Figure 2* when dealing specifically with suspended timber floors in dwellings.

In general all pipework and ancillary components installed for the control of radon should be clearly labelled in order to avoid erroneous connection to other services.

The performance of preventative or corrective actions will be dependent upon the ability of site management to maintain quality control. The onus is on the designer to prepare a design and specification which takes into account the limitations of the site conditions. Many materials and techniques are susceptible to damage unless work on site is carefully co-ordinated and weather conditions are suitable. Care should be taken to ensure that existing service pipes and cables are not damaged and that essential damp proof courses and membranes are properly reinstated if they are disturbed during the implementation of radon corrective options.

The designer should take the following measures in order to reduce the risk of poor results;

- produce a well thought through method statement which follows a logical sequence of site operations,
- consider the level of operative skill and supervision available during construction,
- provide adequate details, particularly where services pass through membranes. If a detail cannot be drawn it cannot be built!
- consider the need for site operative training,
- ensure adequacy of site supervision/inspection.

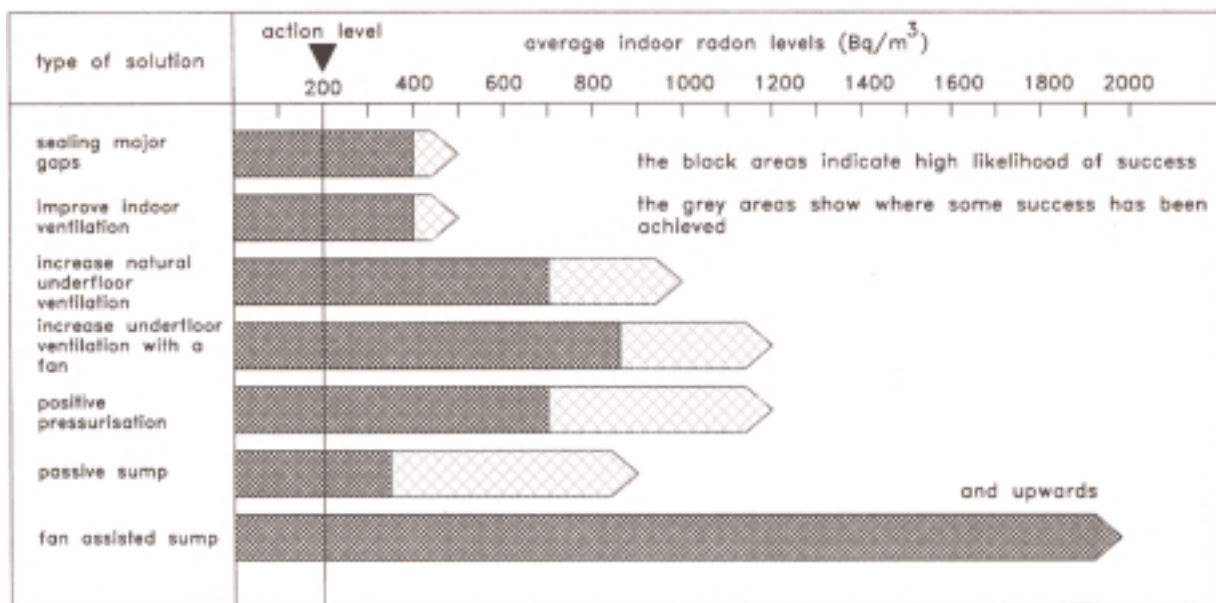

Fig 2 guide to the likely effectiveness of solutions

Sealing soil gas routes

Tests have established that the radon concentration and pressure of soil gas are the dominant factors contributing to indoor radon problems and that the most common method of infiltration is through cracks and other openings in the ground floor and adjoining walls.

To control infiltration in an existing building it is necessary to make the floors and walls more effective barriers by sealing all the points of entry. Unfortunately, this is not easily achieved and requires a degree of quality control which is not normal in construction work. Experience has shown that missing even minor openings in a sealing process will compromise the exercise since the gas flow is pressure driven. Nevertheless, by a combination of careful inspection and thorough workmanship, it is usually possible to significantly reduce the inflow of radon.

For existing concrete floors, all coverings, skirtings etc. must be removed in order that all cracks and leaks are dealt with. Materials used for this sealing work should be flexible, permanently elastic and capable of adhering to a variety of surfaces. Buildings are to some degree dynamic in the sense that minor movement may occur from year to year and, unless the sealant is able to flex with the building, cracks will reappear. High quality sealant, such as silicone, polysulphide and polyurethane, are most likely to be successful. See reference 11 for guidance on the selection of sealant.

In existing buildings with timber floors it is extremely difficult to seal soil gas routes. Sealing of existing oversite concrete is not normally a practical proposition. In this case the use of other options, including extraction of gas from the underfloor void, may be more appropriate.

Depressurisation/pressurisation of underlying soil

Depressurisation of the underlying soil can be used to modify the pressure gradient between the soil and the building in order to limit the entry of radon.

In a building with a floating concrete floor slab, this will usually mean providing, in the permeable hardcore layer under the slab, a sump or collection chamber into which the radon gas is drawn and from which it is piped to the outside air (*Figure 3*). The sump may be situated either centrally or close to external walls, having regard to its likely area of influence.

Where clean permeable hardcore is used a single sump is likely to have an influence over an area of at least 250m³ and for a distance at least 15 m from the sump¹². Where there is doubt about the permeability of the hardcore it may be necessary to carry out manometric surveys (*reference 13*) to determine the area of influence of proposed sump locations. Obstructions below the floor slab may reduce the effectiveness of the system and it may be necessary to provide a number of separate sumps with pipework connected to a single rising pipe (*see Figure 4 and 5*).

The building should be surveyed to ascertain those rooms in which high radon concentrations occur and to determine the most suitable configuration of sumps and extraction pipework.

One option is draw off radon from a centrally located, hand excavated sump (*Figure 6*) by cutting through the floor internally. Proper reinstatement of the damp-proof membrane and sealing the junction between the old and new concrete will be required. Care is needed to ensure that underfloor services such as water, central heating and electricity supplies etc. are not damaged. Particular attention should be paid to the reinstatement of the concrete around the pipe at floor level and a sealant should be used around the pipe to prevent air from inside the building being drawn into the sump. The pipework from the sump should be taken to an external discharge point. This will generally mean taking the pipework up through the roof with a fan, if necessary, fitted as close as possible to the outlet to minimise the danger of release of gas into the building.

Alternatively access to the permeable layer may be gained from a point or points outside of and adjoining exterior walls (*Figure 7*). This would involve breaking through the rising wall, extracting fill to create a small void and inserting a pipe to reduce the underfloor pressure and draw off the soil gas out

into the open air. Sealing of the pipes to the masonry is essential in order to avoid drawing air from outside the building (*Figure 8*). If a fan is necessary, consideration should be given to locating it in the attic space because durability and maintenance problems are likely to be greater when external pipework and fans are used.

While it may be necessary to use an electrically operated fan to draw the radon off, a passive system involving a sump and pipework taken up through the building (or above the eaves on an external wall) may be sufficient to reduce the underfloor pressure. These use wind or stack effects to extract soil gas from the underbuildings and it has been used successfully for levels in excess of 800 Bq per cubic meter¹⁴. However, its success is dependent on many influences such as cowl design, wind direction and wind eddies and it may be necessary to add a fan if high concentrations of radon persist.

A fan-operated system involves an element of noise nuisance, costs of installation, running and maintenance and requires good quality workmanship, with particular attention to sealing pipework joints, minimising noise transmission¹⁵ and dealing with condensation etc. However, it is the most reliable of current methods when radon levels are high.

Where fans are used they should be wired directly to a fused distribution board to reduce the possibility of accidental switch off. All electrical work should be in accordance with ETCI regulations¹⁶. *Figure 9* is a diagrammatic sketch of typical layouts for a fan-assisted system.

The air in the pipework will often be at a higher temperature than the surrounding air in attics or on external walls and this will lead to the formation of condensation in the pipes. It is important to protect the fan from damage due to condensate; this can be achieved by keeping the fan very close to the pipe terminal and, if necessary, by providing for collection/drainage of the condensate in a suitable way. The horizontal section of pipework from the sump should run with a slight rise away from the sump (to avoid the danger of water in the pipe forming a gas trap), through an external wall where it can be turned up and capped until needed.

In some situations, notably on sites underlain by extensive granular soils, depressurisation can cause radon to be extracted in quantity from a wide area. On such sites, pressurisation of the underlying soil through reversing the action of the fan may reduce the tendency for radon gas to be drawn into the building and prove successful in lowering radon gas levels.

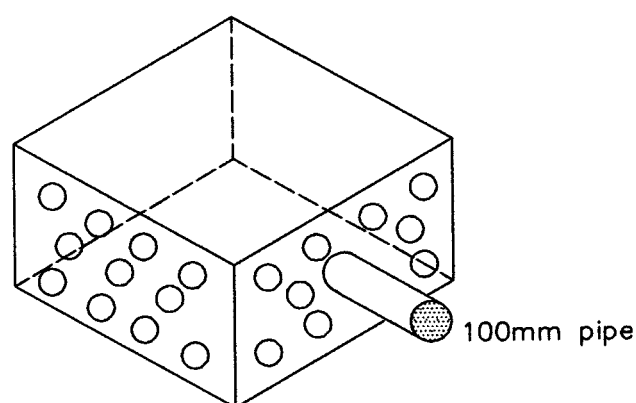

Fig 3 prefabricated collection box

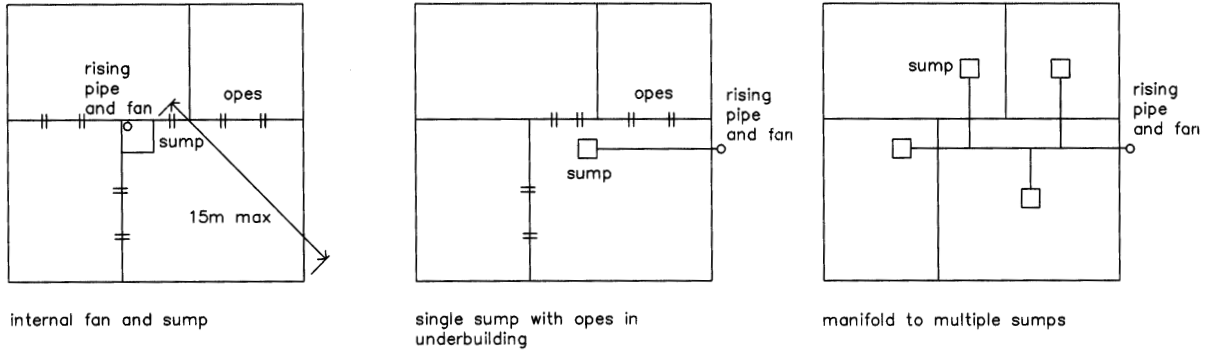

Fig 4 sump layout options

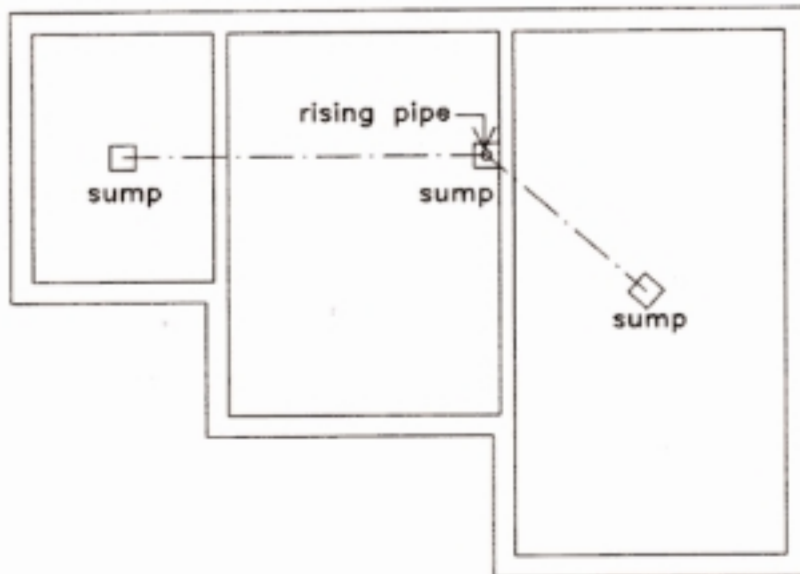

Fig 5 interconnected sumps

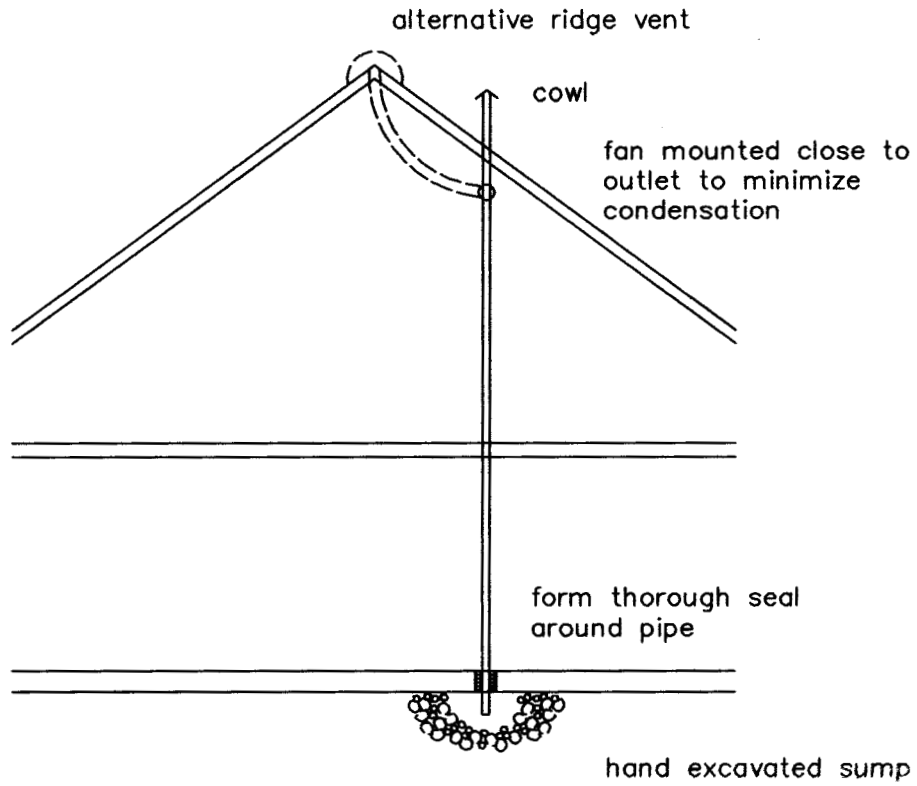

Fig 6 hand excavated

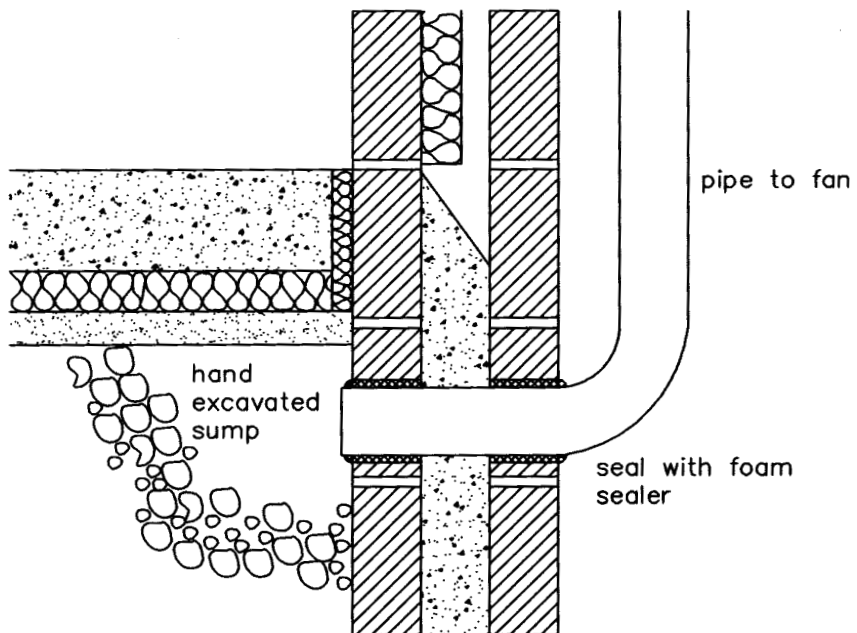

Fig 7 externally excavated sump

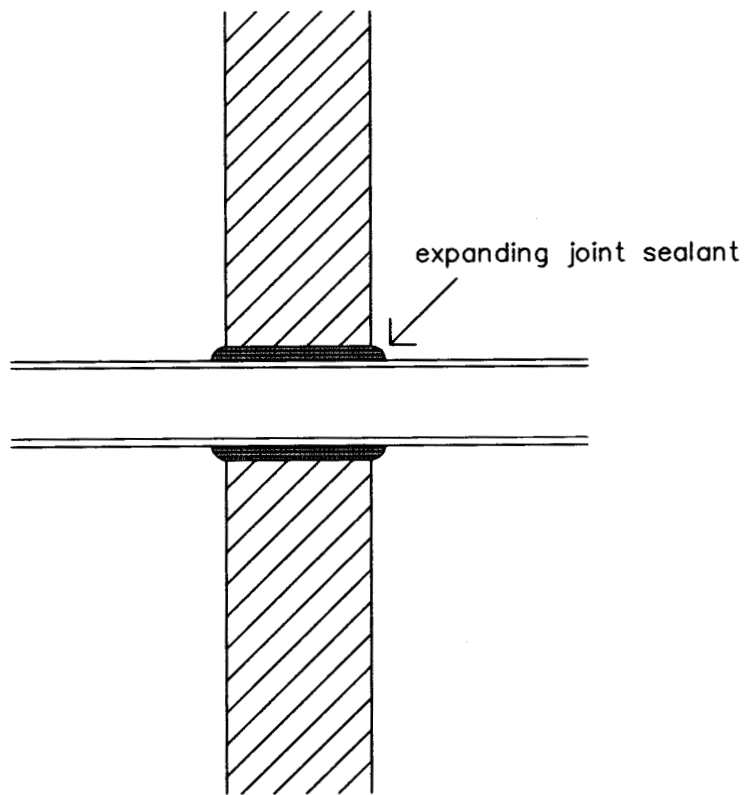

Fig 8 sealing pipe through external wall

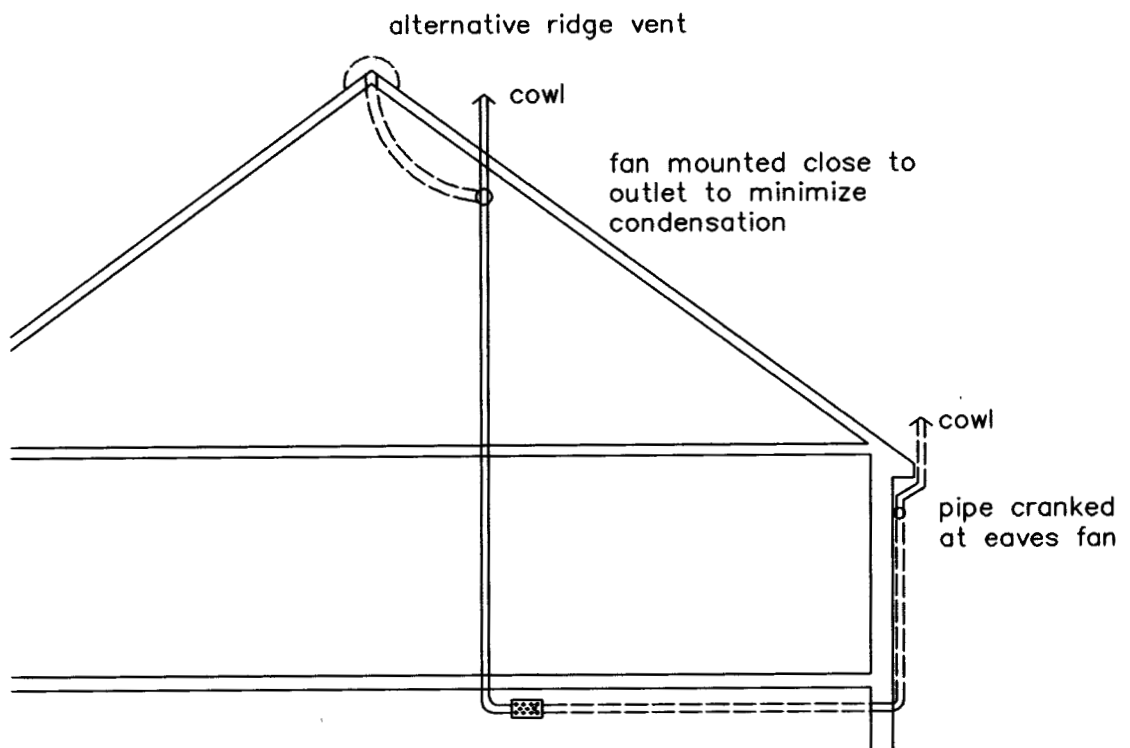

Fig 9 typical layout of fan assisted system

Ventilation of sub-structure

Ventilation is the process whereby internal air is gradually replaced by air from outside. Natural ventilation is driven by pressure differences caused by wind or by differences in air density between the enclosed space and the external environment.

Existing buildings with radon levels up to 850 Bq/m^3 that have a suspended type of ground floor construction may have an easily remedied situation. The air space under the floor effectively disconnects it from the ground and offers the opportunity of intercepting the rising soil gas and removing it before it can enter the building. The under floor ventilation normally provided to remove rising ground moisture can usually be increased to allow a strong undercurrent of outside air to constantly replace the soil gas as it emerges from the ground. The free area in old brick vents may be increased through replacement with modern vents or it may be necessary to increase the number of vents on the leeward side of the building (*Figure 10*). As increased air movement under the floor will have a cooling effect it may be necessary to install floor insulation to limit the resulting energy penalty. The ease of adding insulation depends on the construction details encountered. Should this approach not result in the desired reduction of radon gas within the building, it would then be possible to resort to fan-assisted ventilation of the building or depressurisation under the oversite concrete.

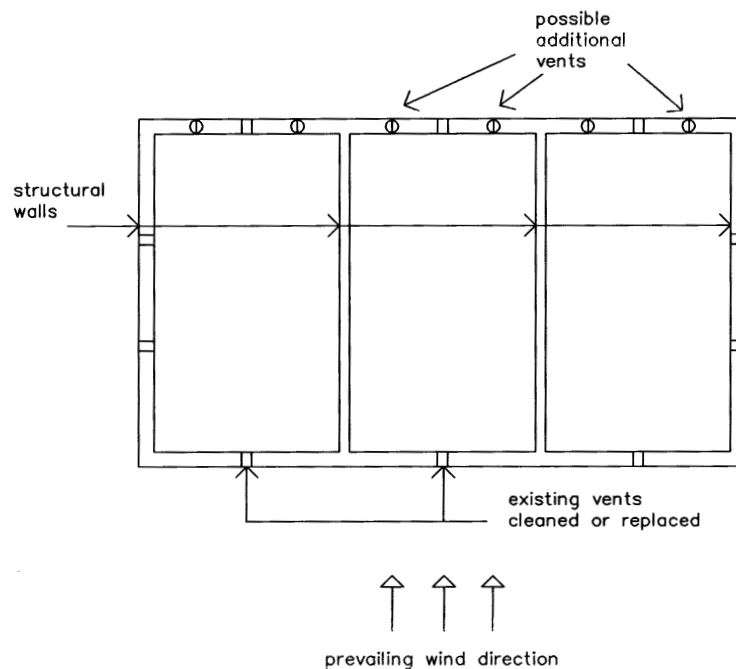

Fig 10 increased ventilation under suspended floor

Ventilation of internal spaces

Increasing the ventilation of living areas, whenever possible, by opening windows on two or more sides of the building is the simplest method of reducing relatively low levels of radon concentration. This will not always be possible for security reasons and in cold weather would be impractical due to discomfort and the increase in heating costs. Installing a mechanically balanced supply/exhaust ventilation system with heat recovery could significantly reduce this additional heating cost. This would introduce and extract air at approximately the same rates, resulting in a neutral pressure within the building. To operate successfully, a balanced system requires a reasonably well sealed building in order to control air movement, and for radon reduction, it is essential that there are properly designed and located air inlets and outlets to allow incoming air to mix with room air. Mechanical ventilation of this type may not on its own be able to remedy high levels of radon but, as well as generally improving the quality of indoor air, it could be a useful supplementary tool with other systems. However, these systems are relatively expensive to install and it is unlikely that they would find wide-scale application in this country.

Pressurisation of internal spaces

It is generally accepted that the use of unbalanced extract fans within a house to improve ventilation is counterproductive in dealing with high levels of radon. The net effect is to reduce the pressure in the house and thereby induce more radon from the soil through any available openings in the ground floor. It should be noted also that the effect of open fires and other combustion appliances is to reduce air pressure within the house and for this reason they should ideally be provided with a dedicated source of outdoor air.

An alternative approach is to use a fan system to provide a positive pressure throughout the house and in that way reverse the normal inflow of soil gas from under the floor.

In a house with a pitched roof this fan unit could be housed in the attic space and an air stream introduced into the house through diffusers in the ceiling. Each room would be slightly pressurised (*Figure 11*) and air forced out through crevices in windows, doors and other openings, reversing the normal inflow. Compared with outside conditions, the air in the attic would be pre-warmed by solar gain for most of the year during the daytime, but during the night time use in very cold weather some pre-warming of the air would be necessary. A temperature controlled small electric heater could remove the chill but would add to the running cost. There are available commercially attic mounted units with single air input diffusers which are designed primarily for condensation control but which could provide the desired pressurisation to control radon gas entry. This system would likely have most success in a reasonably well sealed house where a constant positive pressure could be maintained with a relatively low powered fan. In particular, care is required to ensure that the attic floor is well sealed so as to ensure that air is not drawn up into the attic by the operation of the fan and thus the whole process short-circuited.

A criticism of this approach is that warm moist indoor air could be forced into the building fabric giving rise to rot and condensation staining. This result is unlikely except in an extremely “tight” structure with few openings to allow the air to escape – a situation that is difficult to achieve in practice. For existing houses without other easy options, this system of pressurisation may provide a solution and would be less disruptive than many other remedies.

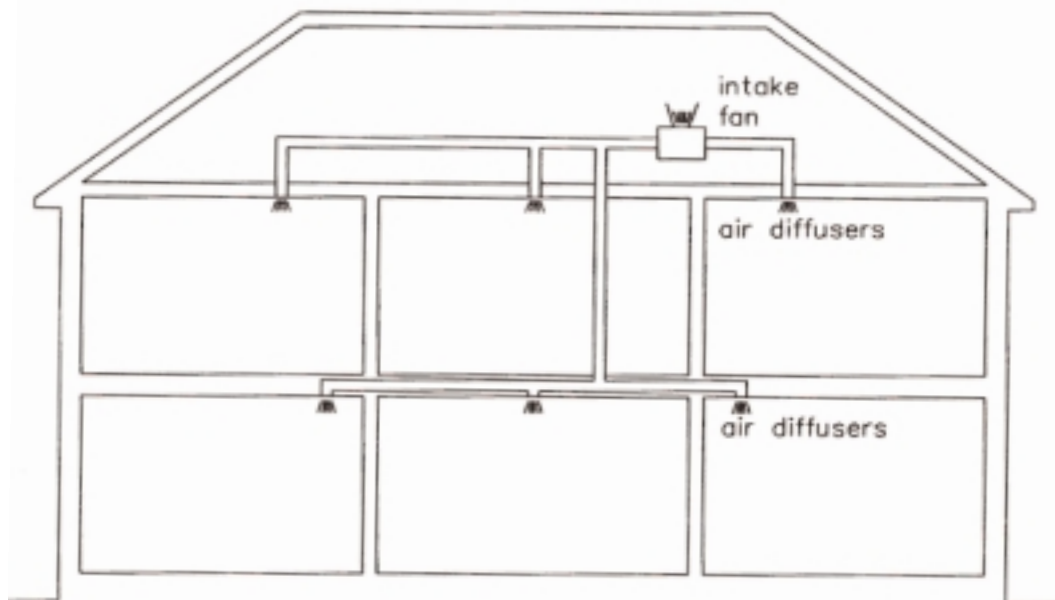

Fig 11 pressurization of internal space

6. Flue gas spillage

Underfloor depressurisation may cause some air from the adjacent rooms being drawn downwards through gaps and cracks in the floor structure and this may give rise to the problem of spillage of flue gasses into rooms in which open flued combustion devices are located (*Figure 12*). **Such spillage is dangerous and must be avoided.** When a depressurisation fan has been installed it is essential that a spillage test is carried out, under conditions of low wind, before the fan and an open flued combustion device are permitted to operate together. Suitable spillage tests are described in “BRE Information Paper IP 21/92”¹⁷. Should the test show that gasses could spill it is necessary to correct this problem before the fan is commissioned. Actions that can be considered include;

- using a fan of lower power,
- reversing the fan to pressurise the underlying soil and force the radon away from the house,
- sealing cracks in the ground floor so as to avoid drawing air from the house,
- replacing the combustion appliance with one which *draws its combustion air from outside the house*,
- modifying the flue to enhance its stack effect etc.

More detailed information on the problem of flue gas spillage is given in GGB 25¹⁸.

Under no circumstances should the fan and the combustion device be allowed to operate together until tests show that spillage is not a problem.

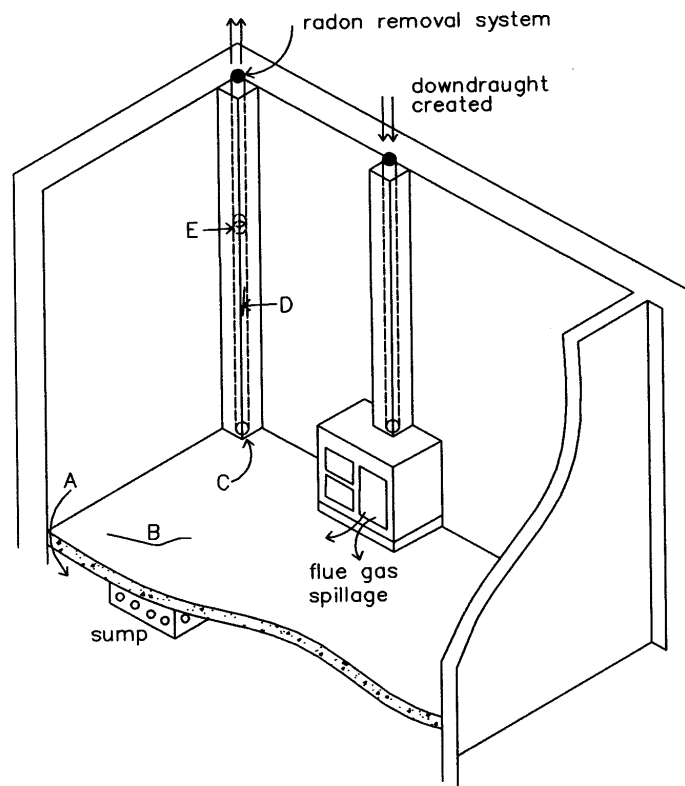

Routes through which fan can draw air from room

- A floor edges
- B cracks in floor
- C joint around pipe
- D cracks in pipe
- E leaking joints in pipe

Fig 12 flue gas spillage

7. Landfill gas

The DOE/LG publication “Protection of Buildings and Occupants from Landfill Gas”¹⁹ explains the background to the problem caused by proximity to landfill sites. There are, however, significant differences between these gasses and radon and although some of the techniques for handling them are similar it is important to note that methane and carbon dioxide are explosive and toxic. Special electrical equipment is required if these are to be mechanically extracted as fans and switches suitable for radon extraction may give rise to sparking which is not tolerable in the presence of landfill gas. Building owners and contractors working on radon remedial works involving buildings located in close proximity to landfill sites, of any age, or in close proximity to other known sources of natural gas should seek professional advise.

8. Conclusion

Where tests have shown that elevated levels of radon exist in a building the procedures suggested in this guide should assist in correcting the problem. However, the radon level should be monitored after the works are completed in order to ensure the success of the measures taken. The building must also be occasionally checked to ensure that the conditions giving rise to the radon have not changed and that the works remain efficient. Where electrical fans are used they must be properly maintained and replaced when necessary.

9. Maps

The following maps (Figure 13 – 17) have been published by the RPII as a result of the National Survey for Irish Dwellings. The national position is given on four sheets, together with an index map, showing the predicted percentage of houses above the National Reference Level of 200 Bq/m³ for each 10 km square.

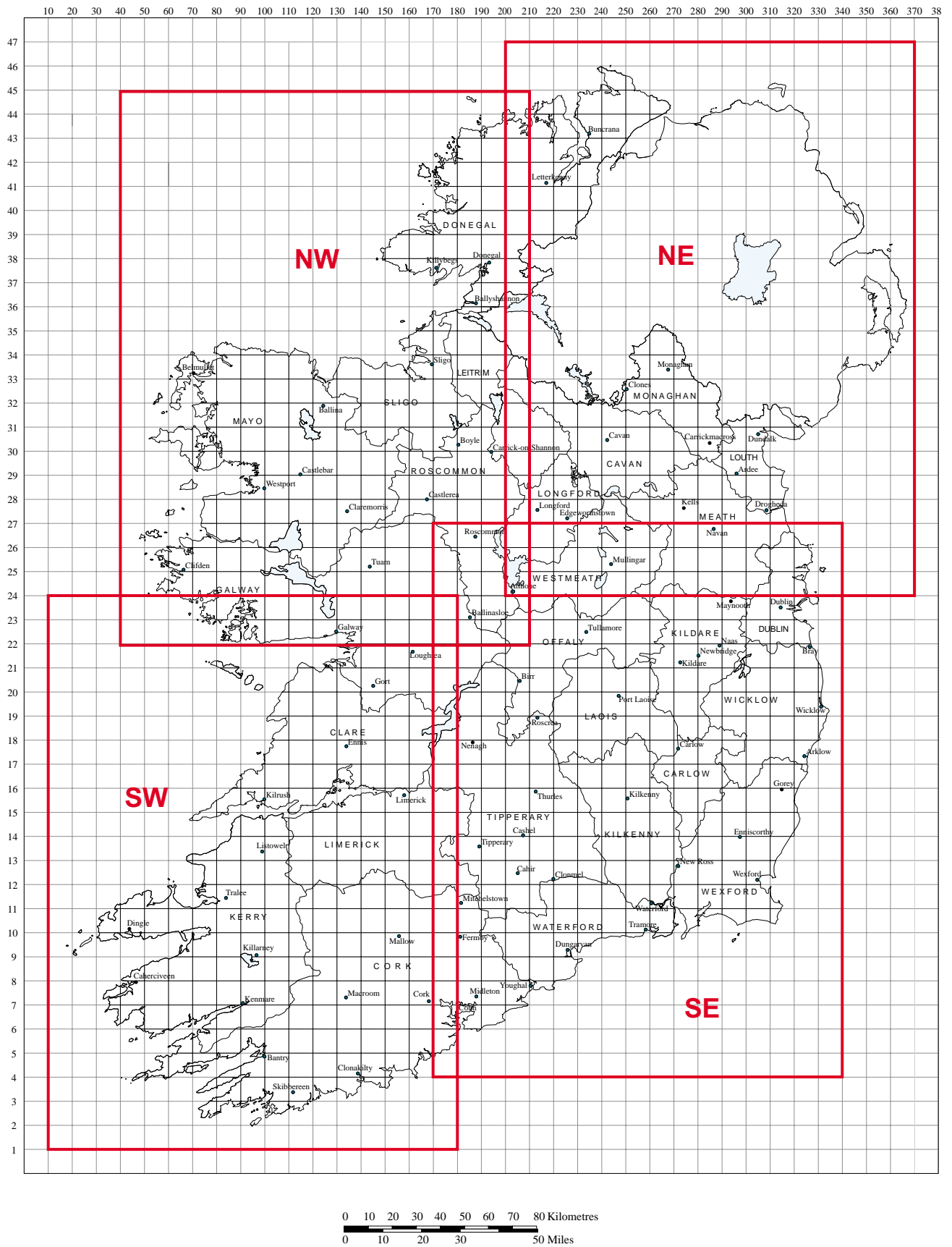
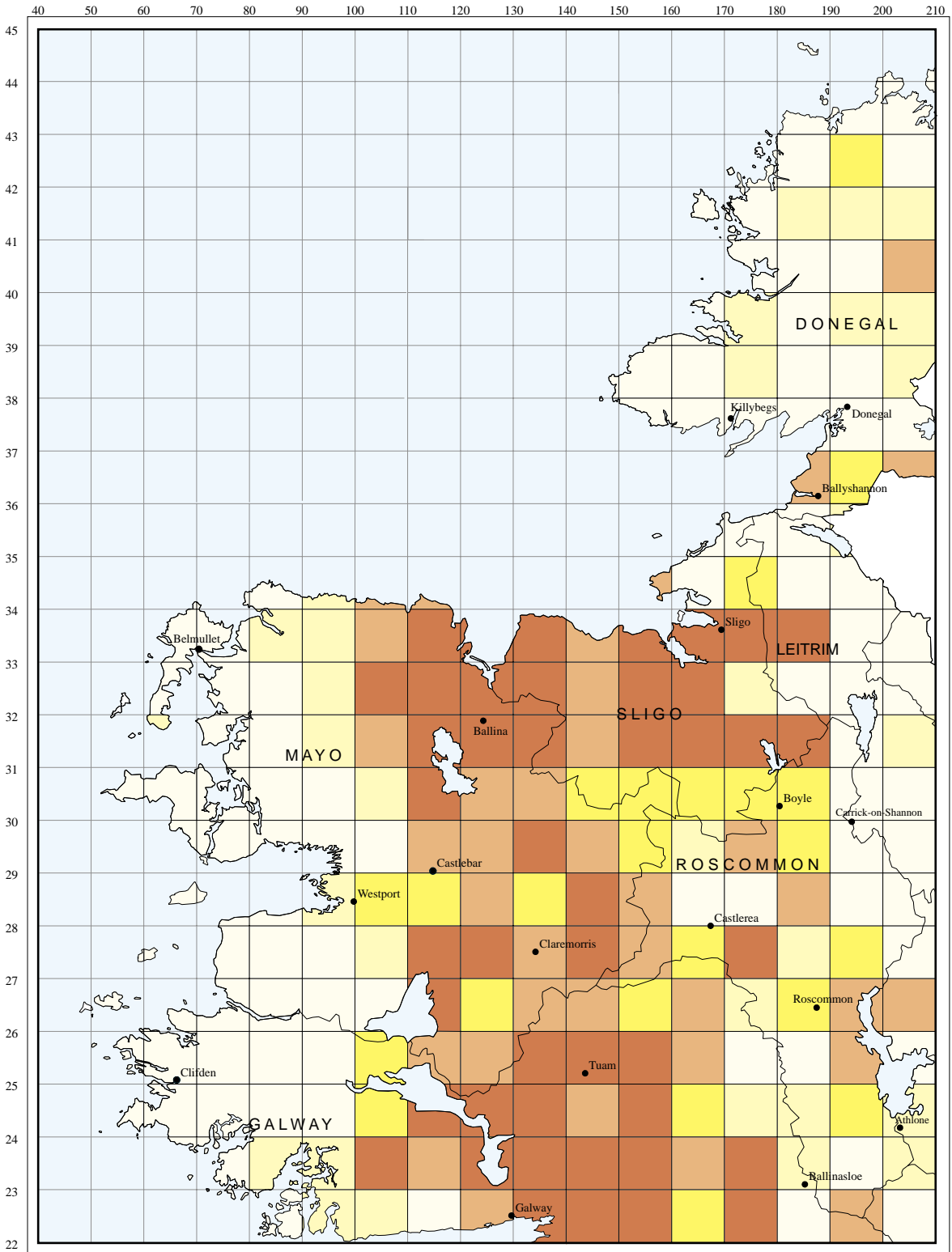

Fig 13: Index Map of Ireland



Estimated Percentage of Dwellings above 200 Bq/m³

| | | |
|--|---|--|
| > 20% | 5 - 10% | < 1% |
| 10 - 20% | 1 - 5% | |

0 10 20 30 40 50 60 70 80 Kilometres
 0 10 20 30 40 50 Miles

Fig 14: Radon Prediction Map for the North West of Ireland

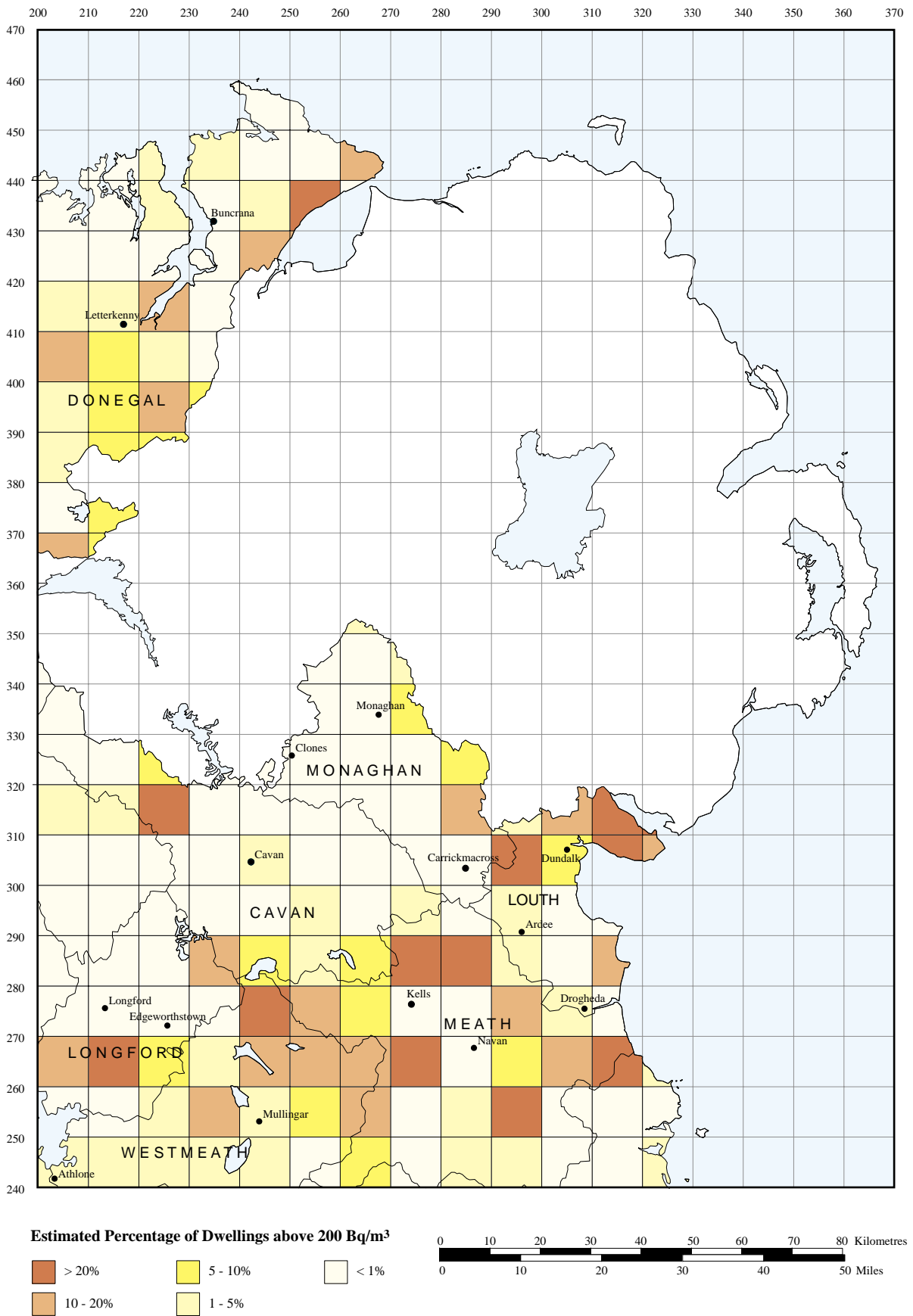

Fig 15: Radon Prediction Map for the North East of Ireland

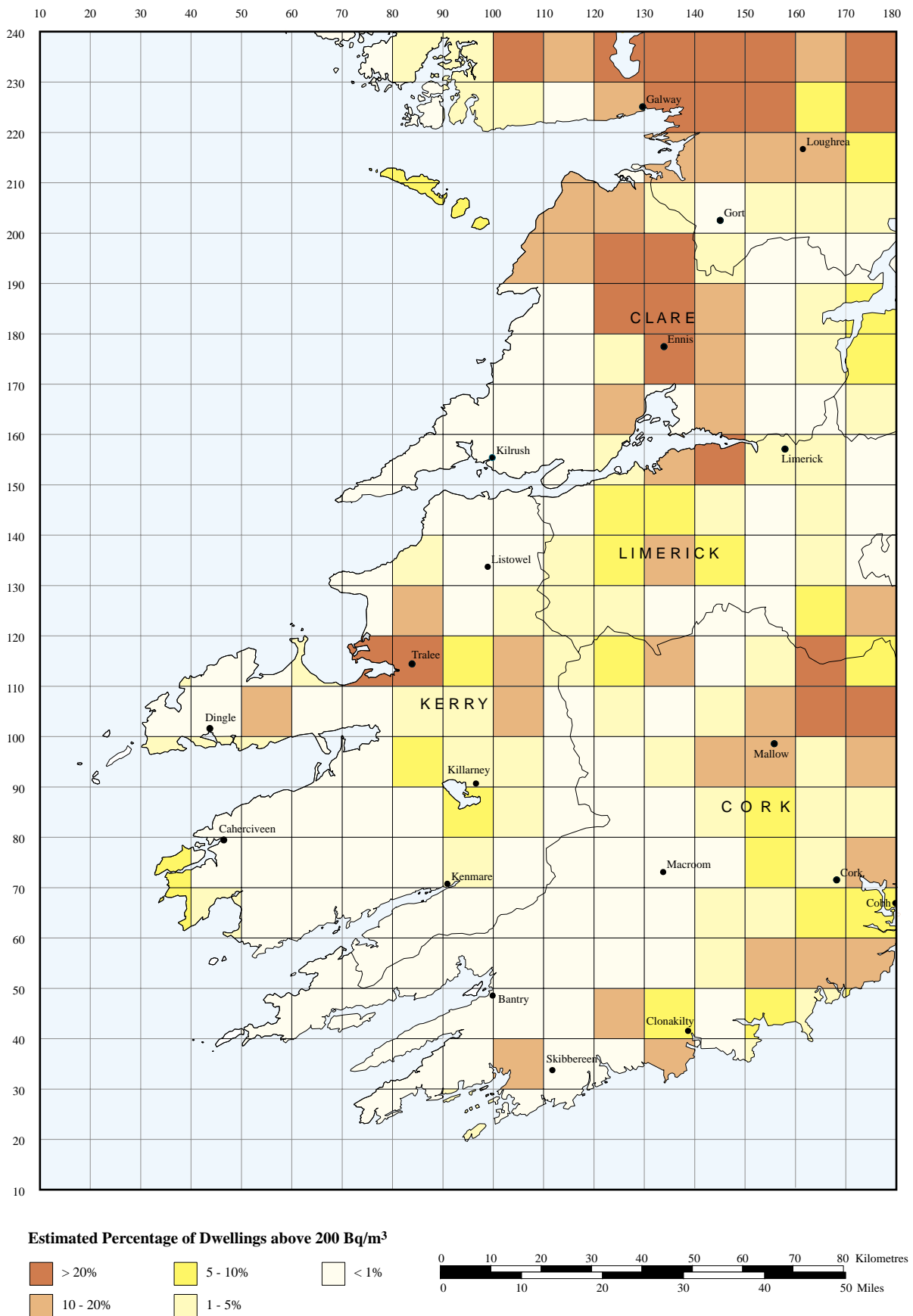
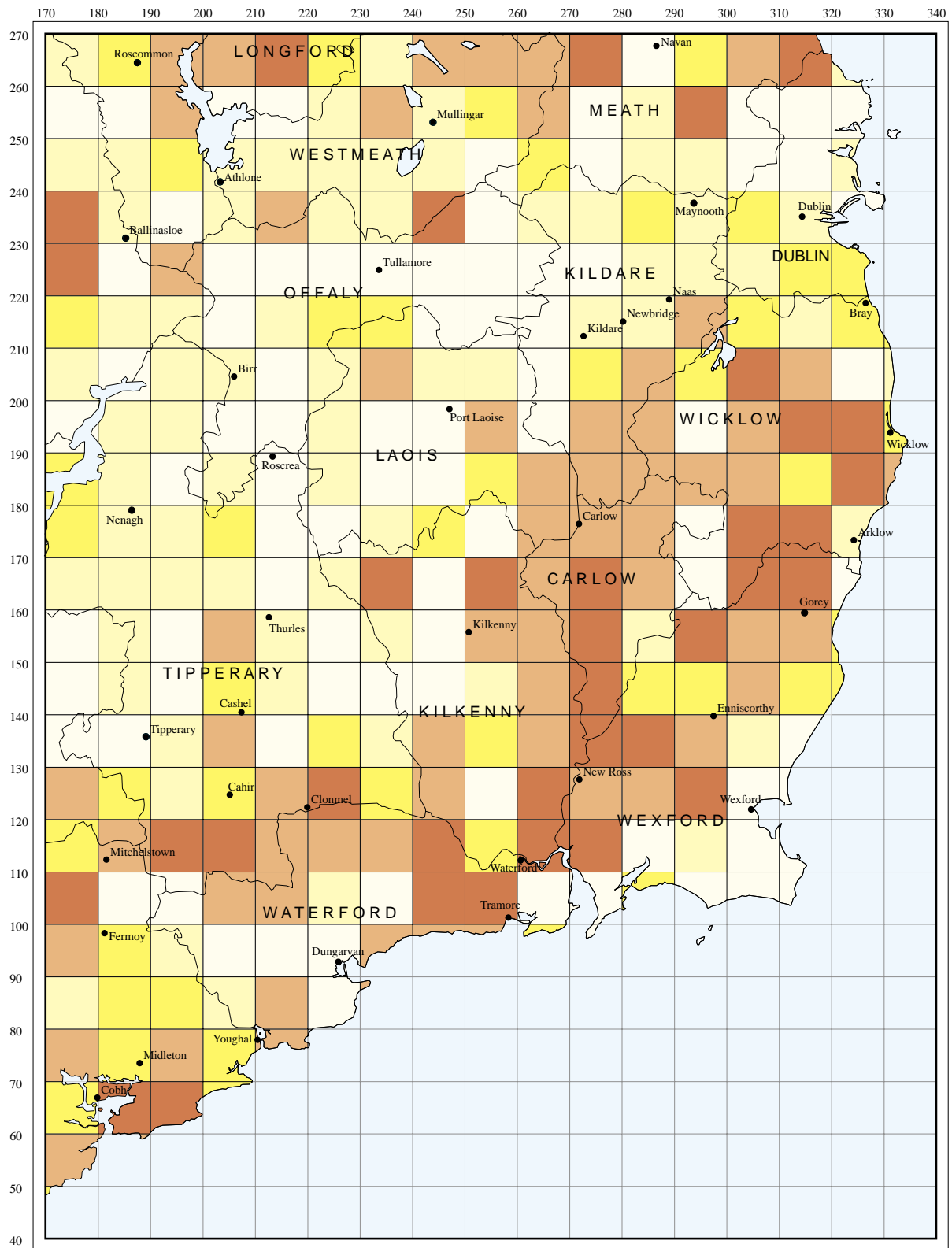

Fig 16: Radon Prediction Map for the South West of Ireland



Estimated Percentage of Dwellings above 200 Bq/m³

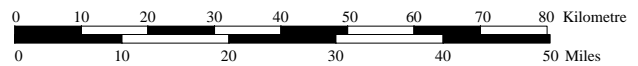
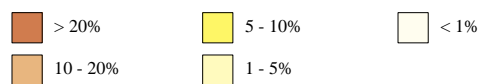

Fig 17: Radon Prediction Map for the South East of Ireland

10 References

- 1 Department of the Environment and Local Government, Technical Guidance Document C to the Building Regulations 1997 – Site Preparation and Resistance to Moisture. 1997.
- 2 Radiological Protection Institute of Ireland, Radon in Dwellings – The National Radon Survey. RPII 01/2.
- 3 ENFO – The Environmental Information Service. Radon, Briefing Sheet 15.
- 4 Planning Radon Surveys in the Workplace, RPII 2001.
- 5 The Radon Council (UK). The Radon Manual, a guide to the requirements for the detection and measurement of natural radon levels, associated remedial measures and subsequent monitoring of results. April 1992.
- 6 The International Commission for Radiological Protection, Protection against Radon-222 at Home and at Work, ICRP Publication 65. 1993.
- 7 Basic Safety Standards for the protection of workers and members of the public from the dangers of ionising radiation.(Council Directive 96/29 EURATOM), Brussels May 1996.
- 8 Radiological Protection Act, 1991 (Ionising Radiation) Order, 2000. S.I. 125 of 2000. Stationary Office Dublin.
- 9 Building Research Establishment (UK). Surveying dwellings with high radon levels: a BRE guide to radon remedial measures in existing dwellings 1993.
- 10 Building Research Establishment (UK). Protecting dwellings with suspended timber floors: a BRE guide to radon remedial measures in existing dwellings 1994.
- 11 Building Research Establishment (UK). Sealing cracks in solid floors: a guide to radon remedial measures in existing dwellings. 1995.
- 12 Building Research Establishment (UK). Radon: guidance on protective measures for new dwellings 1991 (revised 1992).
- 13 U.S. Environmental Protection Agency. Handbook – Sub-Slab Depressurization for Low-Permeability Fill Material – Design and installation of a Home Radon Reduction System 1991.
- 14 Building Research Establishment (UK). Buildings and Radon – Good Building Guide, Passive radon sump systems, communal radon sump systems, spillage of combustion products, protecting new extensions and conservatories, GBG 25 1996.
- 15 Building Research Establishment (UK). Minimising noise from domestic fan systems, Good Building Guide, GBG 26 1995.
- 16 Electrotechnical Council of Ireland. ET101 national rules for electrical installations, 1991.
- 17 Building Research Establishment (UK). Spillage of flue gasses from open flued combustion appliances, BRE Information Paper IP 21/92 1992.
- 18 Building Research Establishment (UK). Good Building Guide GBG 25, Buildings and Radon, 1996.
- 19 Department of the Environment and Local Government. Protection of Buildings and Occupants from Landfill Gas. 1994.

11. Further Reading

Building Research Establishment (UK). Radon sumps: a BRE guide to radon remedial measures in existing dwellings 1992.

Building Research Establishment (UK). Positive pressurisation, a BRE guide to radon remedial measures in existing buildings 1995.

Building Research Establishment (UK). Radon and Buildings 3, Protecting new extensions and conservatories 1994.

Department of the Environment and Local Government. The Building Regulations, 1997.

Department of the Environment (UK). The Householder's Guide to Radon, Second Edition, 1991.

Geological Survey of Ireland. Assessment of the geological factors influencing the occurrence of radon hazard in a karstic region. Report series 93-2 1993.

McLaughlin, J.P. Indoor Radon: Sources, Health Effects and Control, Technology Ireland, July/August 1990.

Mueller Associates, Inc. Handbook of Radon in Buildings (1988). Prepared for U.S. Department of Energy.

National Radiological Protection Board for the Department of the Environment for Northern Ireland. Radon in Dwellings in Northern Ireland (1993).

National Radiological Protection Board (UK). Board Statement on Radon in Homes (1990).
Nazaroff, W. and Nero A., Radon and its Decay Products in Indoor Air (1988).

Scivyer C R and Gregory T J, Radon in the Workplace, Building Research Establishment (UK) 1995.

The Institution of Engineers of Ireland. Radon in buildings, proceedings of seminar held in Galway, Cork and Dublin. 1992.

U.S. Environmental Protection Agency. A Citizen's Guide to Radon.

ISBN 0-7076-9281-4

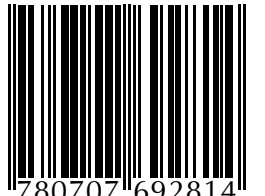

9 780707 692814